

1

2

3

4

5

JST SMR-03V-B

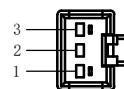
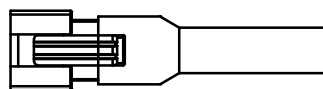

芯数

定义

1

正

2

空

3

负

延长线型号

SM24-Lx (x代表线长: 1/3/5)

unit: mm

A

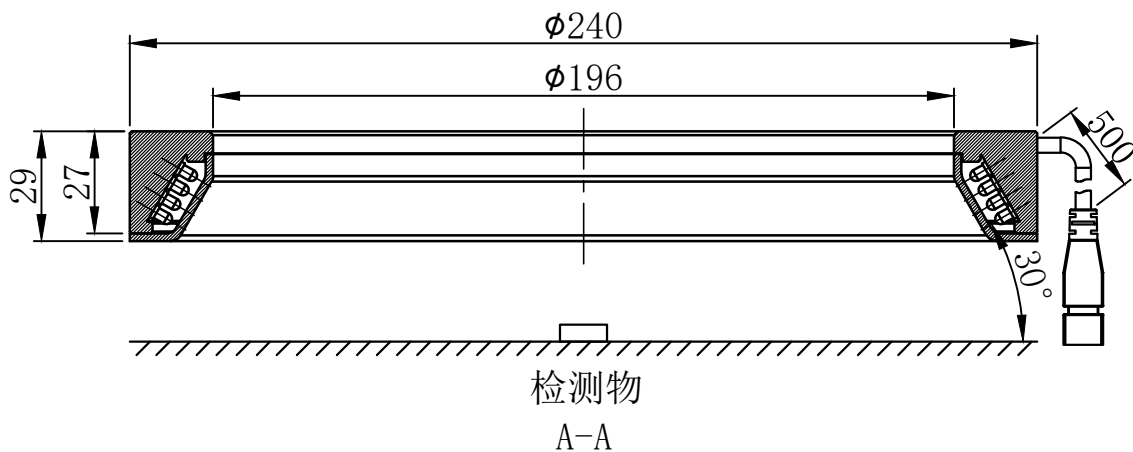

B

C

D

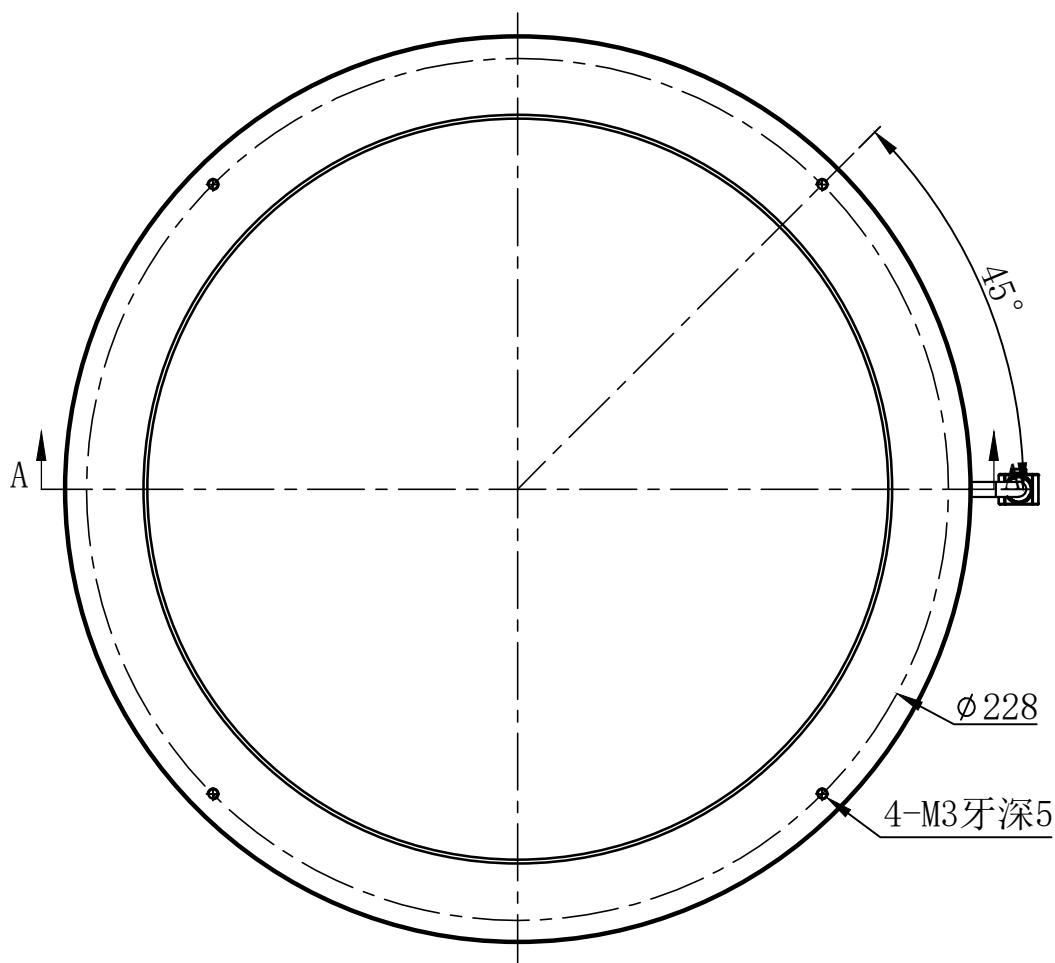

E

设计者

尺寸图版本号

1.0

型号

CRT-RL24030

产品安装尺寸图

曾工

日期

2021-12-01

品名

环形光源



比例

1:2

重量

CR LED